

FB SERIES LED Flood Light

5 YEAR
WARRANTY



Areas of application

- Recreational sports
- Billboard lighting
- Accent lighting
- Parking lots
- Roundabout
- Outdoor sports

Product Benefits

- Up to 100,000hrs @ L70, low maintenance cost
- World class, approbated quality components (LEDs /Driver /etc.)
- Equip with vent to avoid internal fogging and frosting
- Wide choice of optics to suit more applications (asymmetrical and symmetrical)
- Buckle design makes it very easy for further maintenance
- 5 years warranty

Product Features

- Luminaire efficacy: Up to 170 lm /w
- Lifetime more than 100,000 hours
- Impact resistance: IK10
- Type of protection: IP66



Product Datasheet

Version 1

Model No	MK-FB1-30	MK-FB1-30+	MK-FB1-40	MK-FB1-50	
Nominal Wattage	30W	30W	40W	50W	
3030 Version	Efficiency Lumen	140 lm /w 4200 lm	155 lm /w 4650 lm	150 lm /w 6000 lm	140 lm /w 7000 lm

Version 2

Model No	MK-FB2-60	MK-FB2-60+	ZMK-FB2-80	MK-FB2-80+	MK-FB2-100	MK-FB2-120	
Nominal Wattage	60W	60W	80W	80W	100W	120W	
3030 Version	Efficiency Lumen	150 lm /w 9000 lm	165 lm /w 9900 lm	145 lm /w 11600 lm	160 lm /w 12800 lm	145 lm /w 14500 lm	145 lm /w 17400 lm
5050 Version	Efficiency Lumen	160 lm /w 9600 lm	170 lm /w 10200 lm	155 lm /w 12400 lm	165 lm /w 13200 lm	155 lm /w 15500 lm	155 lm /w 18600 lm

Version 3

Model No	MK-FB3-150	MK-FB3-150+	MK-FB3-180	MK-FB3-180+	MK-FB3-200	MK-FB3-240	
Nominal Wattage	150W	150W	180W	180W	200W	240W	
3030 Version	Efficiency Lumen	145 lm /w 21750 lm	160 lm /w 24000 lm	150 lm /w 27000 lm	155 lm /w 27900 lm	145lm /w 29000 lm	140 lm /w 33600 lm
5050 Version	Efficiency Lumen	155 lm /w 23250 lm	165 lm /w 24750 lm	160 lm /w 28800 lm	165 lm /w 29700 lm	155 lm /w 31000 lm	150 lm /w 36000 lm

*Above values are calculated based on the product with CCT over 3000K, values of 3000K are 5% lower than above values.

*Luminous Efficacy of Asymmetrical is 5% lower than other Light Distributions.

*Values shown are subject to ±5% tolerance.

Electrical Data:

Nominal Voltage	AC 100-240V /277V 50 /60Hz
LED	Philips Lumileds
Driver	Inventronics (Default) /Other brands on request
Power Factor (PF)	>0.95
THD	<15
SPD	10KV (Build-in Driver) /Extra 10KV SPD (Available on request)
Optics	25°, 60°, 90°, 120° or Asymmetrical
Standard Deviation of Color Matching	<5 SDCM
CRI	Ra>70 (Default) /Ra>80
CCT	3000K, 4000K, 5000K, 5700K

General Data

Body Material	High pressure die-cast aluminum
Housing Color	Gray (Default) /Black (available on request)
Cover Material	Tempered glass
Lens Material	UV-resistant Polycarbonate
Working Environment	-40°C ~ +50°C, 10%~90%RH
Lifespan L70 at 25 °C	>100, 000 h
Mounting Type	Bracket mounted
Mounting Location	Wall /Pole /Floor /Ceiling
Dimmable	1-10V Dimming (Default) /Timer Dimming
Protection Class	Class I (Default) /Class II
Standards	CE, RoHS, ENEC, CB, LM79, LM80, TM-21, IP66, IK10
Available on request	Photocell, Motion sensor, NTC, OLC, Solar Compatible, DALI Dimming

Product Datasheet

Structure Drawing:



Dimension:

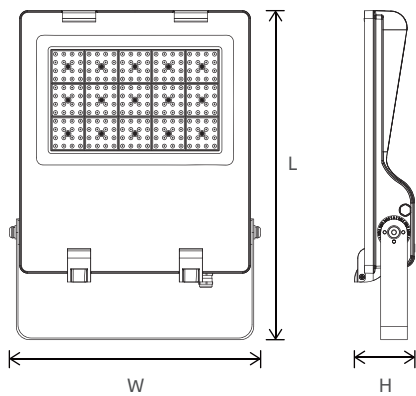

Fixture Information

Version	L1 xW1 xH1	Weight
1	345 x226 x81mm	2.3kg
2	447 x321 x90mm	4.4kg
3	495 x378 x90mm	6.0kg

Package Information

Version	L2 xW2 xH2	Weight
1	350 x295 x145mm	2.9kg
2	425 x385 x140mm	4.9kg
3	470 x445 x145mm	6.7kg

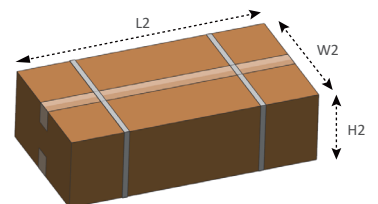
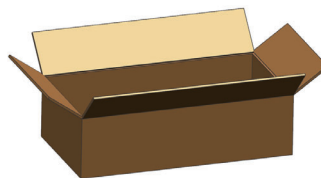

Product Datasheet

Light Distributions

Order reference

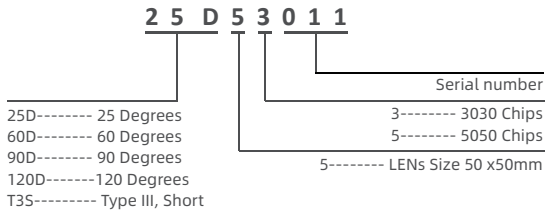

3030 Version

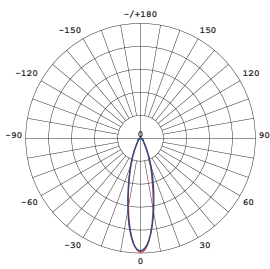

25D53011

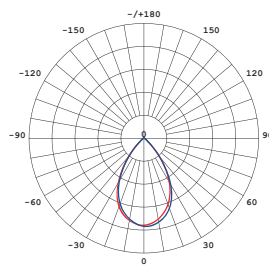

60D53012

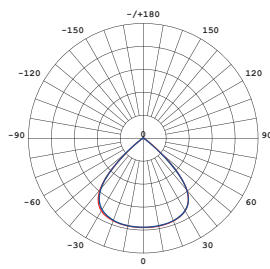

90D53013

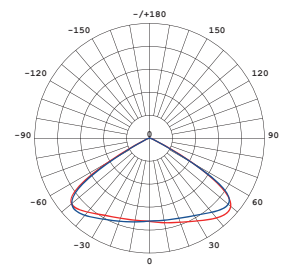

120D53014

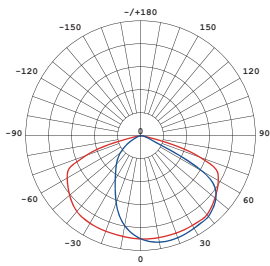

T3S53002

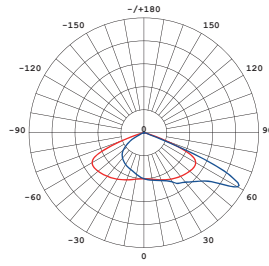

T3S53003

5050 Version

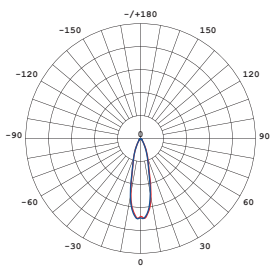

25D55017

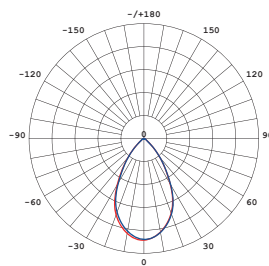

60D55015

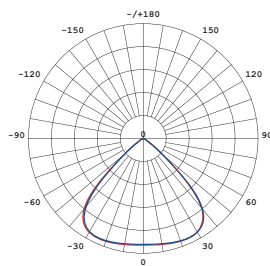

90D55016

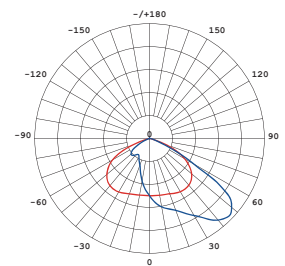

T3S55006

Optional accessories

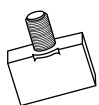

Photocell



PIR Sensor

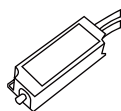

Smart Controller

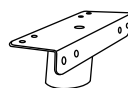

Pole Adapter

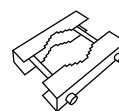

Clamp Bracket

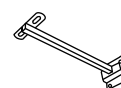

Mounting Arm

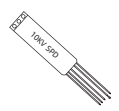

Extra 10KV SPD